

Lightning holders • Round conductor folders

Wire holder thread h=8cm (galvanized steel) /OC/

CATALOG NO. : AH07111

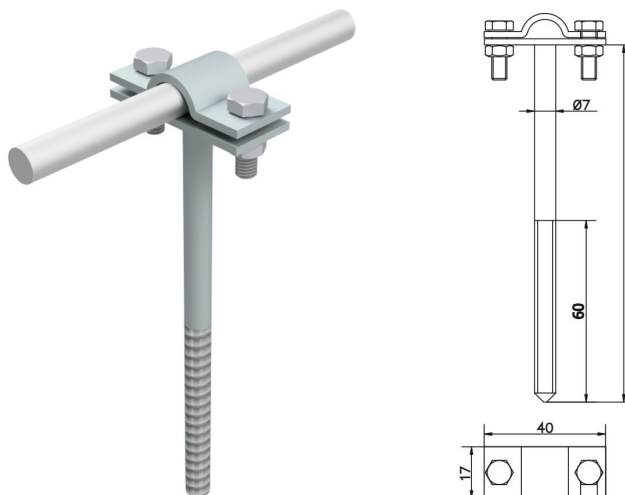

GTIN	5901832914556
Material	electro-galvanized steel
Round conductor/flat tape range [mm]:	Ø8-10
Bolt	2xM5x16
Screw / nut material	galvanized steel
Height / length [mm]	L=80
Others	B- maximum tape width; dedicated product : sleeve Ø12x60mm (cat No AH29050)

Due to continuous technical development, AH Hardt sp.j. reserves the right to introduce technical and technological changes of the products. The illustrations shown are not binding.