

Connectors • Test connectors

## 4-hole test connector wire-tape B up to 30mm (hot-dip galvanized steel) /OG/

CATALOG NO. : AH0302OG

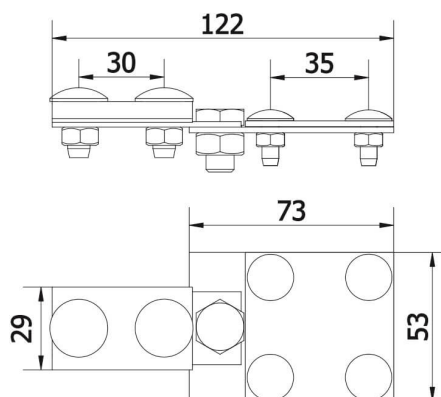
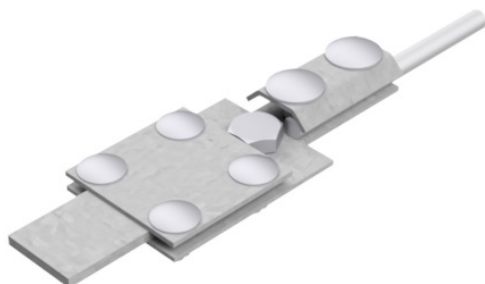

GTIN	5907675560110
Material	hot-dip galvanized steel
Round conductor/flat tape range [mm]:	Ø8/B up to 30
Bolt	4xM6x16; 1xM10x16; 2xM8x20
Screw / nut material	galvanized steel
Others	B- maximum tape width

Due to continuous technical development, AH Hardt sp.j. reserves the right to introduce technical and technological changes of the products. The illustrations shown are not binding.